

SIDEBOARDS

CABINET WITH DRAWER

5043

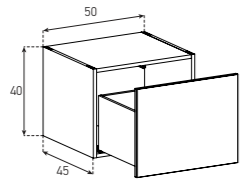

6543

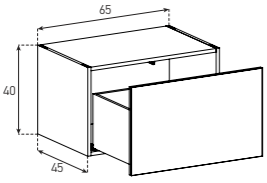

5082

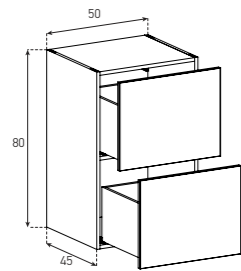

5084

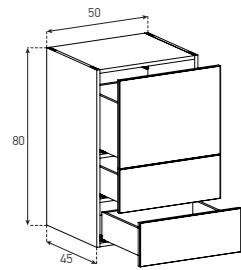

6582

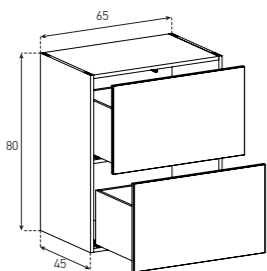

5061

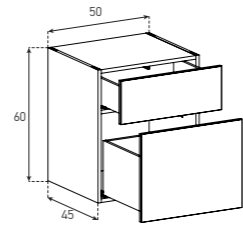

6562

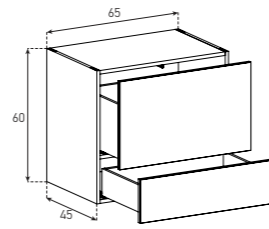

5083

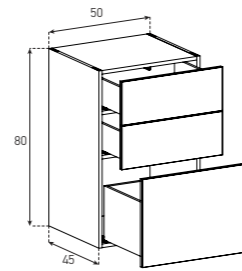

5062

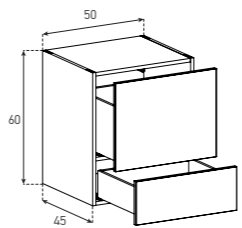

6561

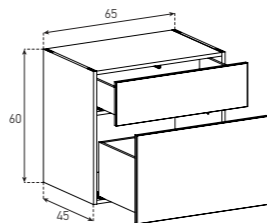

10043

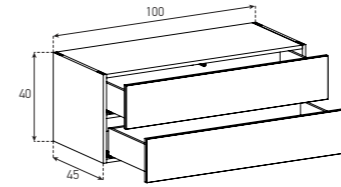

6583

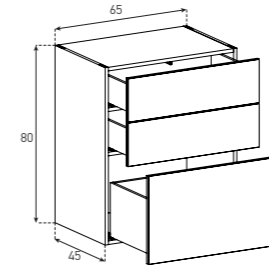

13043

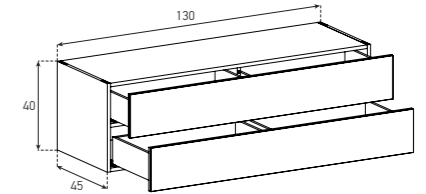

6584

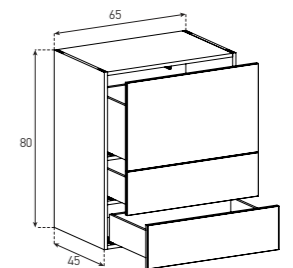

CABINET WITH DOOR

5045 R&L

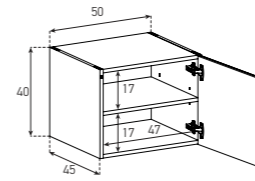

5064 R&L

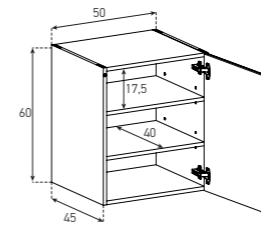

10062

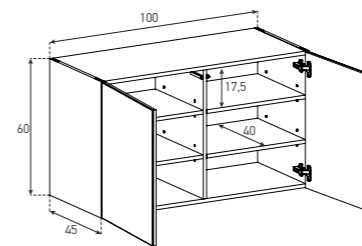

10044

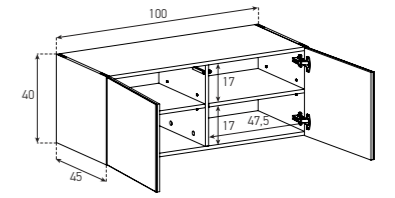

6566 R&L

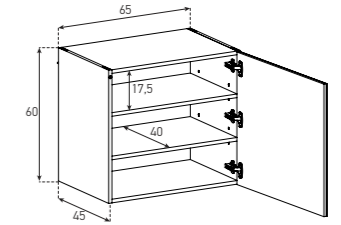

5086 R&L

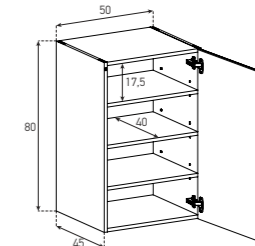

50102 R&L

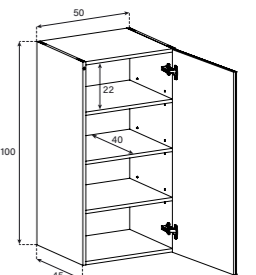

10083

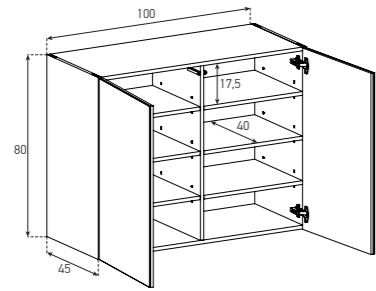

5164 R&L

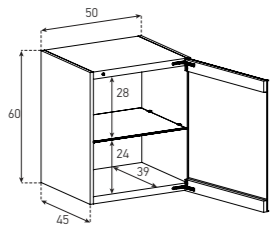

5186 R&L

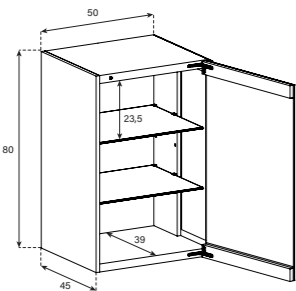

CABINET WITH FLAP DOWN

5041

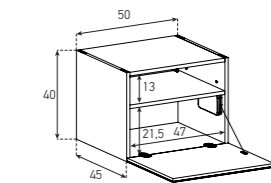

10041

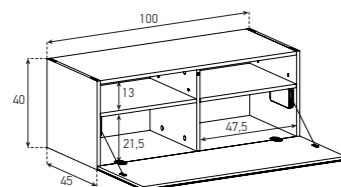

10162

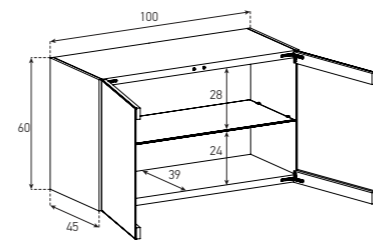

10183

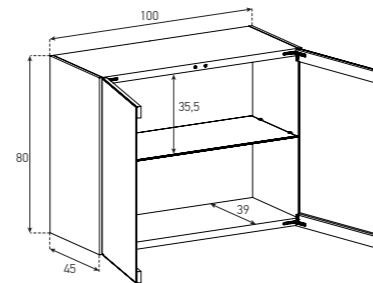

101101

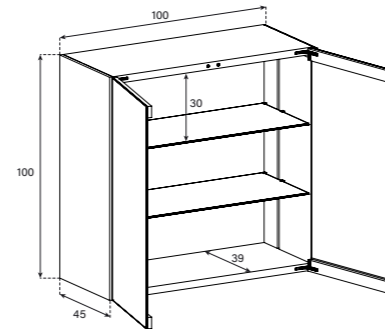

6541

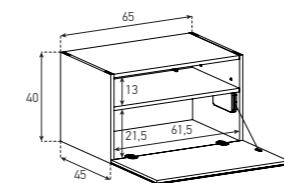

13041

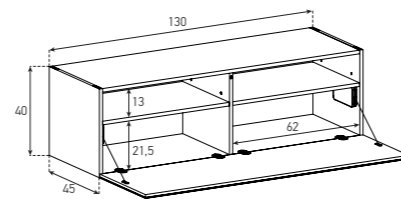

5042

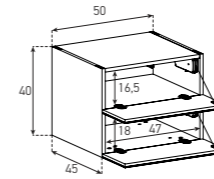

10042

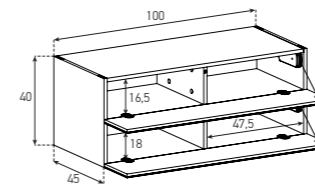

5081

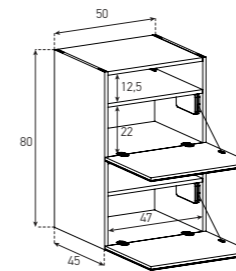

10081

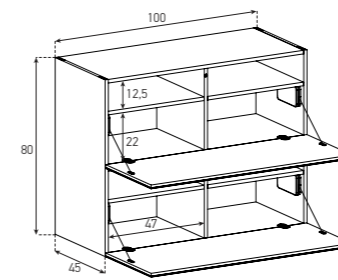

5046

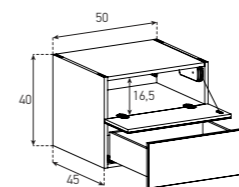

6542

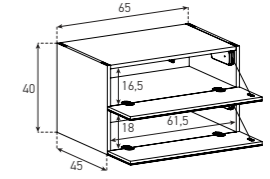

13042

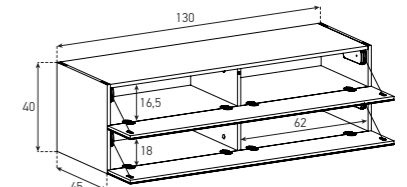

6581

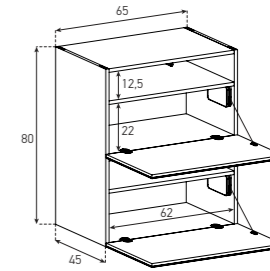

13081

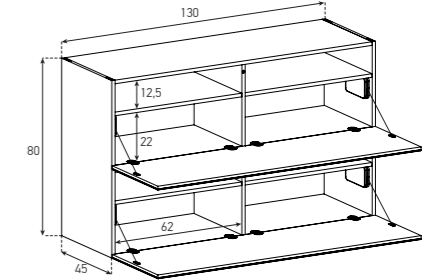

COMBO CABINETS

6545

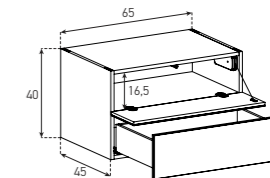

10045

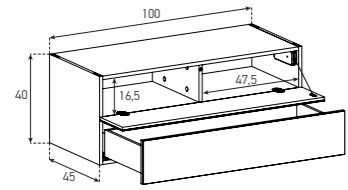

13044 T/P

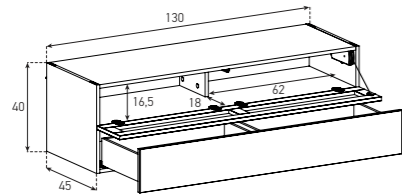

5066

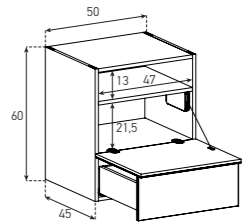

6565

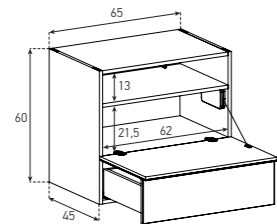

10063

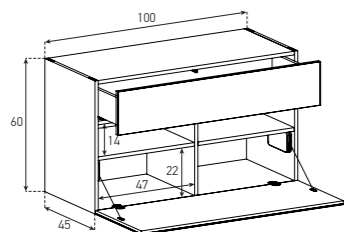

13044

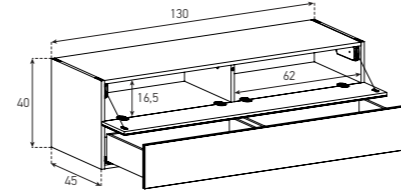

5065

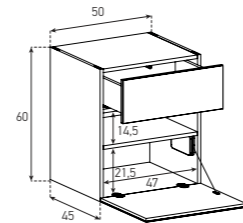

6564

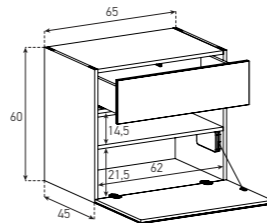

6567

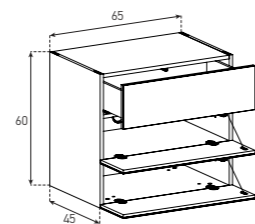

10064

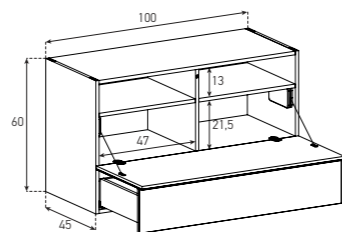

10064 T/P

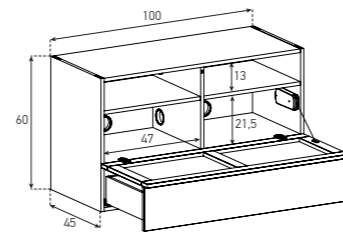

10065

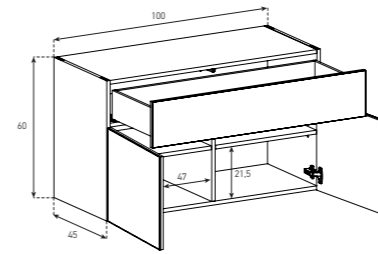

13063

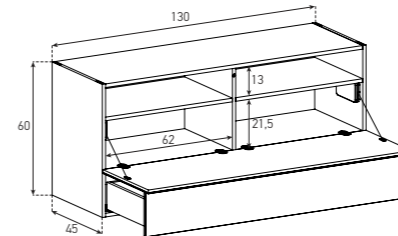

13064 T/P

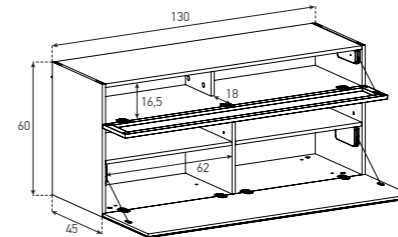

5088

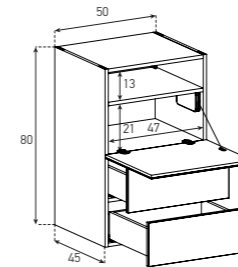

6586

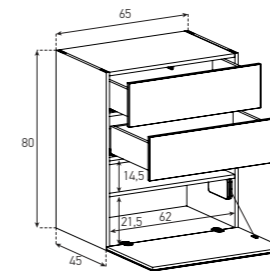

13062

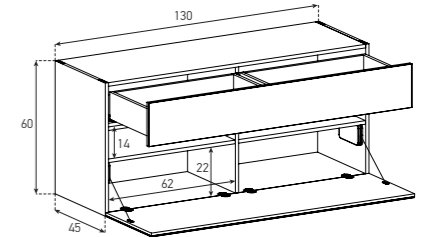

13063 T/P

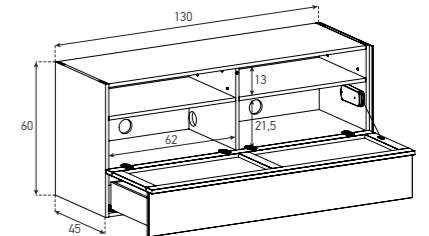

5087

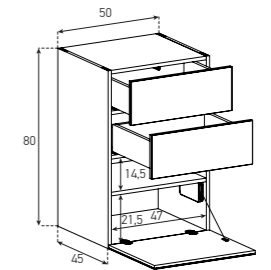

5089

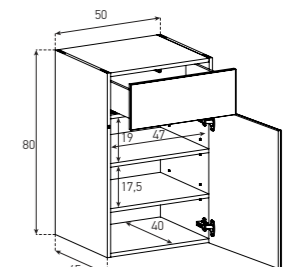

6587

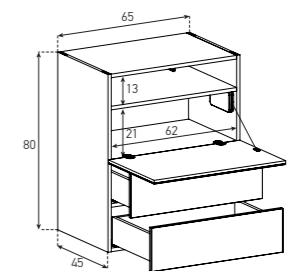

10084

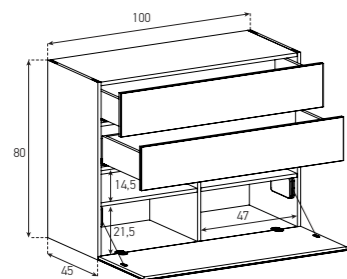

10085 T/P

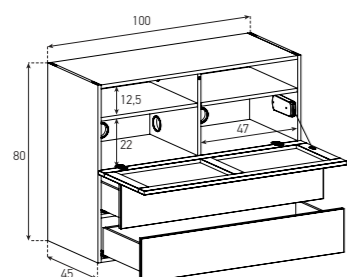

13083

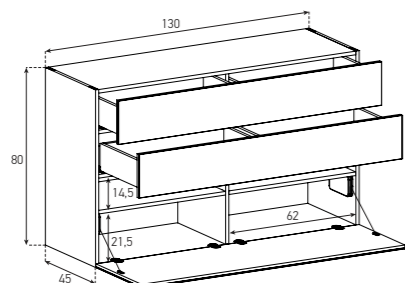

13084 T/P

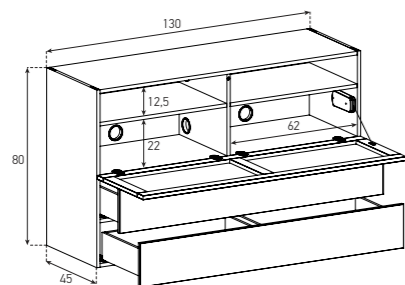

100121

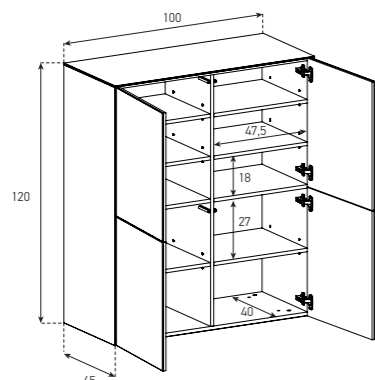

10085

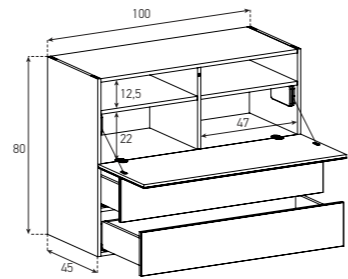

10086

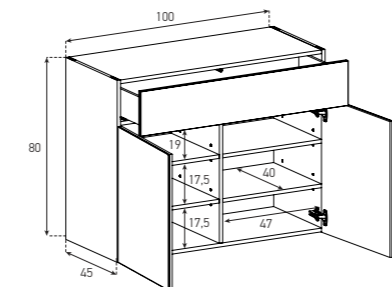

13084

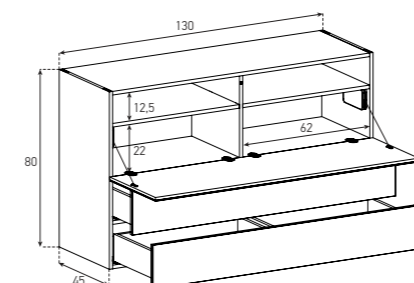

BAR

100122

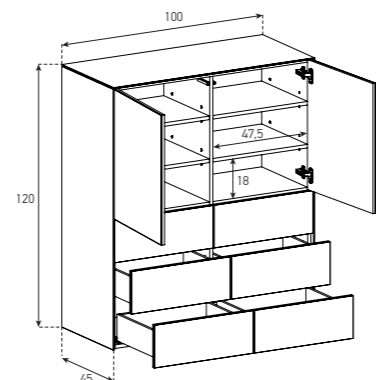

100123

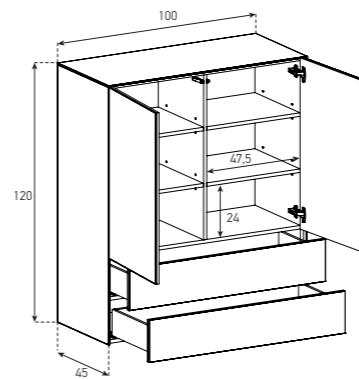

100125

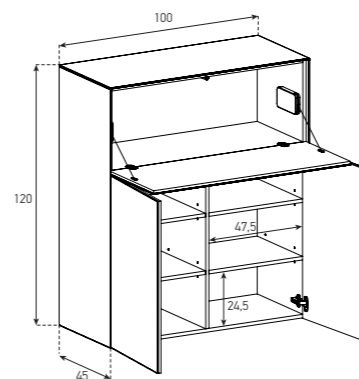

120121

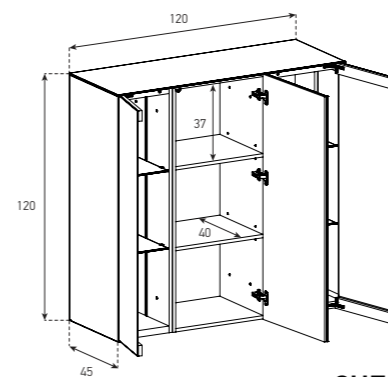

100124

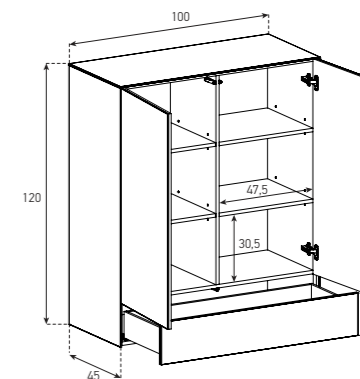

100126

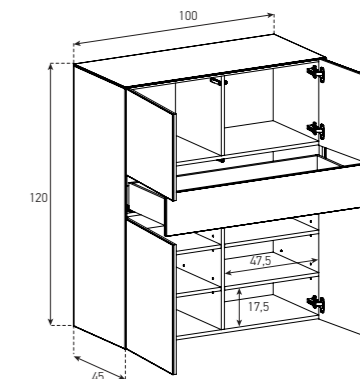

120101

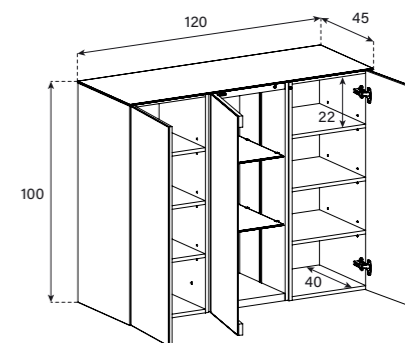

CHEST OF DRAWERS & BEDSIDES

KLBS-42

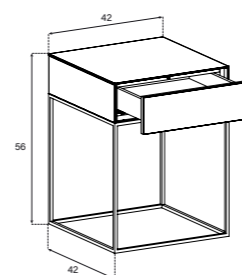

KLBS-42S

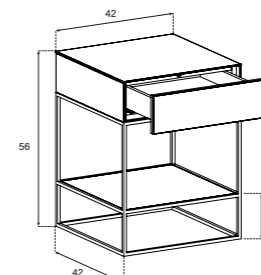

5044

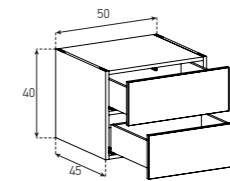

6544

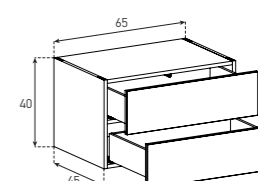

5063

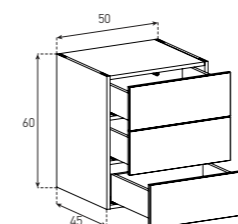

10061

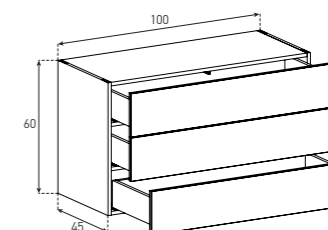

6563

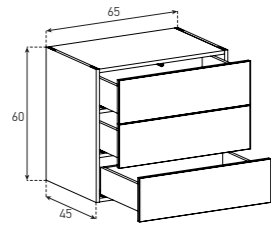

5085

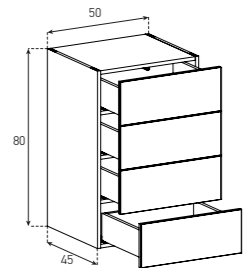

50101

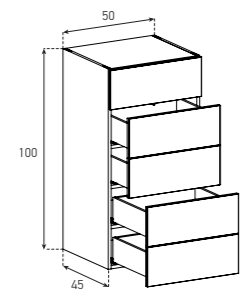

6585

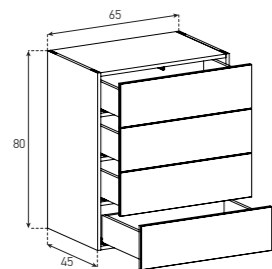

13082

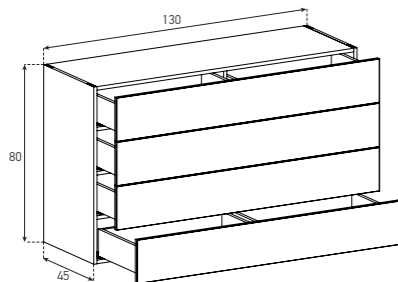

13061

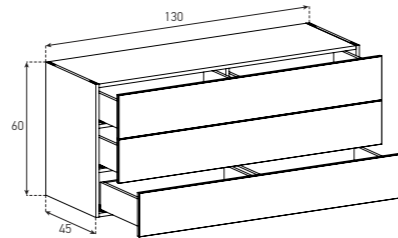

10082

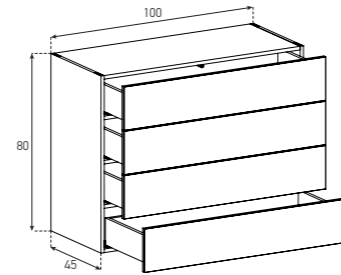

100101

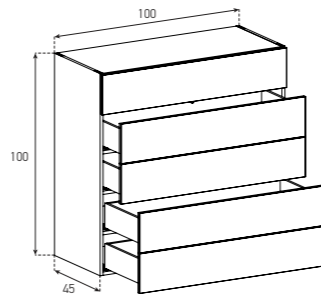

65101

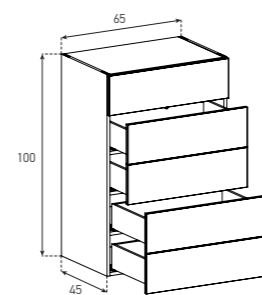

130101

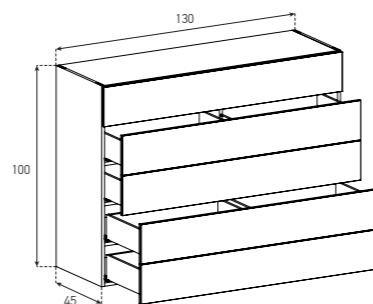

**Sideboards
CODE SAMPLE**

SB-5061-WHT-BS-A(WHT)

1 2 3 4 5

1) Cabinet Types :

	50cm	65cm	100cm	130cm
40cm	504#	654#	1004#	1304#
60cm	506#	656#	1006#	1306#
80cm	508#	658#	1008#	1308#
100cm	5010#	6510#	10010#	13010#



Total combination size can not exceed 260cm

2) Door Colors & Decors : "Category (A, B, C, D, E & F) "

3) Base Options : "Category (B) "

BS (3,5cm Base)	CG2 (20cm Metal Cage)	CRB (13cm Metal Crab)	S20 (20cm Metal Spike)	S13 (13cm Metal Spike)
WL (Wall Hanging)	CG4 (40cm Metal Cage)	TBE (13cm Metal Tube)	PLN (13cm Metal Plain)	CLB (28cm Metal Club)



5) Side Glass Colors : (D Type structure doesn't have side glass) "Category (A) "

TOP GLASS CODE SAMPLE

SB-TG-WHT-195

TG = TOP GLASS GLASS COLOR SIZE¹ (CM)

METAL LEG CODE SAMPLE

SB-SPK-GRY-195

3 LEG COLOR SIZE¹ (CM)

1. Total length of combination
- Bars can not be a part of combination